



**Kalstein**<sup>®</sup>

A different accompaniment, at your service

# LABORATORY LINES

## MICROSCOPE

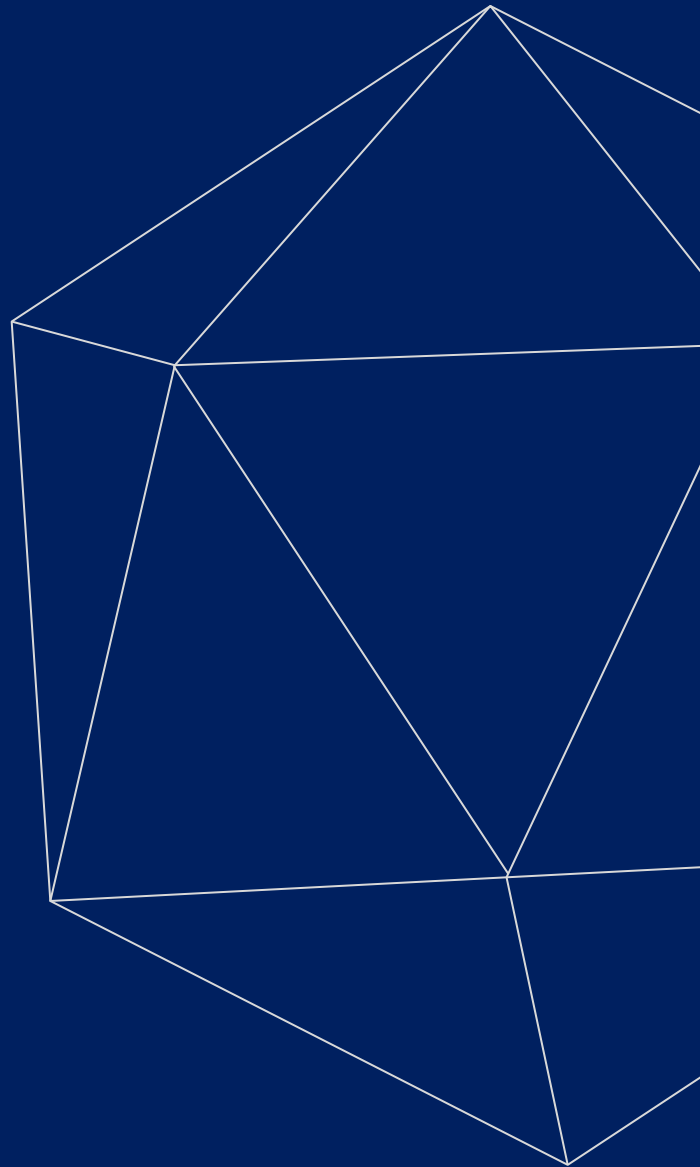

OUR SERVICES

## Benefits and Support

In Kalstein France, we take care of the full satisfaction of our customers, that is why we provide value-added services of the highest level based on our experience.



### Online Inductions and Trainings

In any part of the world, receive your induction or training from our specialized team of engineers



### Quick Response

Our work team is always available to response all your consults or questions, in order to support you in any situation.



### #Letsgivemore

Thanks to your purchase, a donation will be made to a non-profit foundation that fights against breast cancer and helps most vulnerable communities.



### Technical Support

Enjoy of personalized advice for the correct preventive and corrective maintenance of your equipment, thanks to Kalstein's manuals and articles, special catalogues and video tutorials.



### Delivery Logistics

We take care of all the necessary logistics for the dispatch of your goods, whether is by sea, land or air.



### Kalstein Worldwide

With more than 25 years growing with our customers, Kalstein's multifomat and modern content, is now present in more than 10 countries and increasing.



## KALSTEIN® Microscope Inverted Microscope Transmit Light Model YR0230A



### #Letsgivemore

Thanks to your purchase, a donation will be made to a non-profit foundation that fights against breast cancer and helps most vulnerable communities.



All rights reserved © KALSTEIN France S. A. S.,  
2 Rue Jean Lantier • 75001 Paris •  
+33 1 78 95 87 89 / +33 6 80 76 07 10 •  
<https://kalstein.eu>  
KALSTEIN FRANCE, S. A. S.



# MICROSCOPE

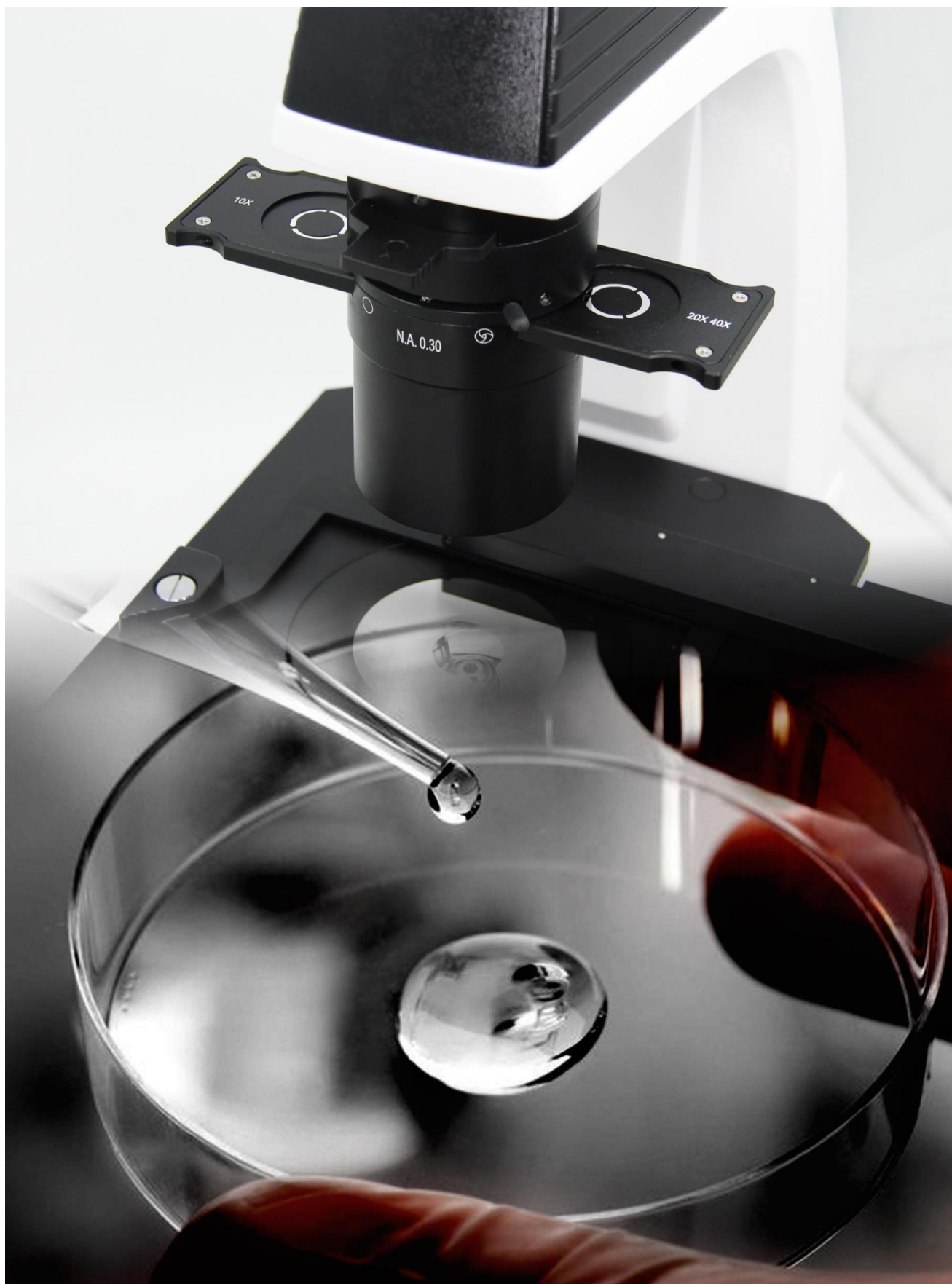

**#Letsgivemore** ♥

Thanks to your purchase, a donation will be made to a non-profit foundation that fights against breast cancer and helps most vulnerable communities.



All rights reserved © KALSTEIN France S. A. S.,  
2 Rue Jean Lantier • 75001 Paris •  
+33 1 78 95 87 89 / +33 6 80 76 07 10 •  
<https://kalstein.eu>  
KALSTEIN FRANCE, S. A. S





# MICROSCOPE



- (1) Dual Photo & Video Channel System
- (2) ECO Automatic Power Off System
- (3) 4 Holes Disc Phase Contrast Condenser
- (4) Halogen 12V50W Koehler Illumination

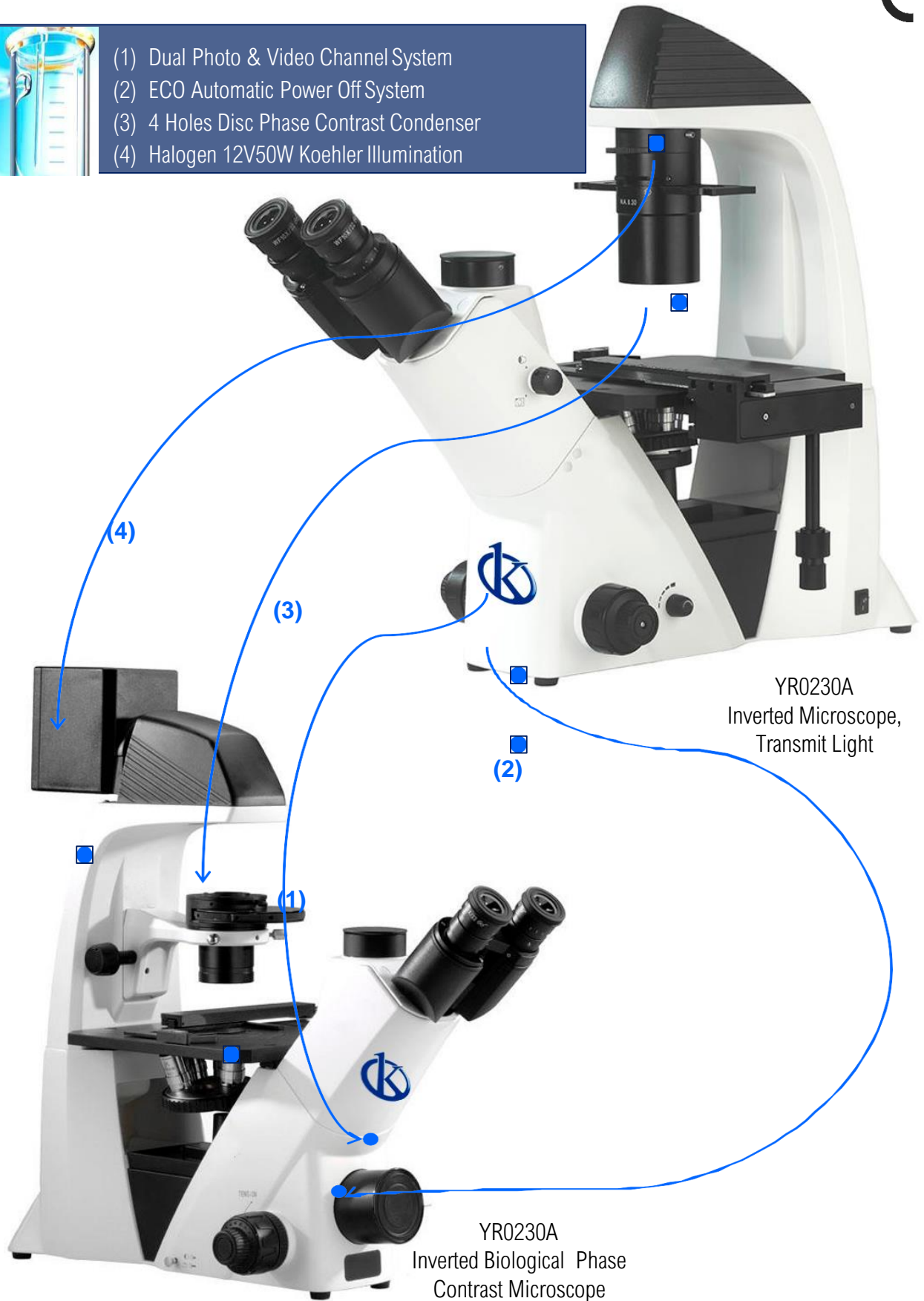

YR0230A  
Inverted Microscope,  
Transmit Light

YR0230A  
Inverted Biological Phase  
Contrast Microscope



**#Let'sgivemore** ♥

Thanks to your purchase, a donation will be made to a non-profit foundation that fights against breast cancer and helps most vulnerable communities.



All rights reserved © KALSTEIN France S. A. S.,  
2 Rue Jean Lantier • 75001 Paris •  
+33 1 78 95 87 89 / +33 6 80 76 07 10 •  
<https://kalstein.eu>  
KALSTEIN FRANCE, S. A. S



## Product Details



### Head & Eyepiece

Seidentopf Trinocular Head Inclined 45° Interpupillary Distance 48~76mm, Light Split Switch  
E100:P0 / E20:P80  
WF10x/22mm, Dia.30mm, High Eyepoint, Diopter Adjustable



Condenser & Light Source With Filters: Blue, Dia.34mm; Green, Dia.34mm Koehler Illumination  
Halogen 6V/30W For YR0230A Koehler Illumination 5W LED For YR0230A



### #Let'sgive more

Thanks to your purchase, a donation will be made to a non-profit foundation that fights against breast cancer and helps most vulnerable communities.



All rights reserved © KALSTEIN France S. A. S.,  
2 Rue Jean Lantier • 75001 Paris •  
+33 1 78 95 87 89 / +33 6 80 76 07 10 •  
<https://kalstein.eu>  
KALSTEIN FRANCE, S. A. S





**Long Working Distance**  
Working Distance 72mm (With Condenser), 195mm (Without Condenser)



**Working Stage**  
Mechanical Stage Size 210x241mm, Round Slide Size  $\Phi$ 110mm  
Culture Dish Holder 54mm  
With Optional Attachable Moving Stage



**#Letsgivemore**

Thanks to your purchase, a donation will be made to a non-profit foundation that fights against breast cancer and helps most vulnerable communities.



All rights reserved © KALSTEIN France S. A. S.,  
2 Rue Jean Lantier • 75001 Paris •  
+33 1 78 95 87 89 / +33 6 80 76 07 10 •  
<https://kalstein.eu>  
KALSTEIN FRANCE, S. A. S







**Objectives**  
LWD Infinity Plan  
Fluorescent Objectives 10x,  
20x, 40x  
LWD Infinity Plan Phase Contrast  
Fluorescent Objectives 20x

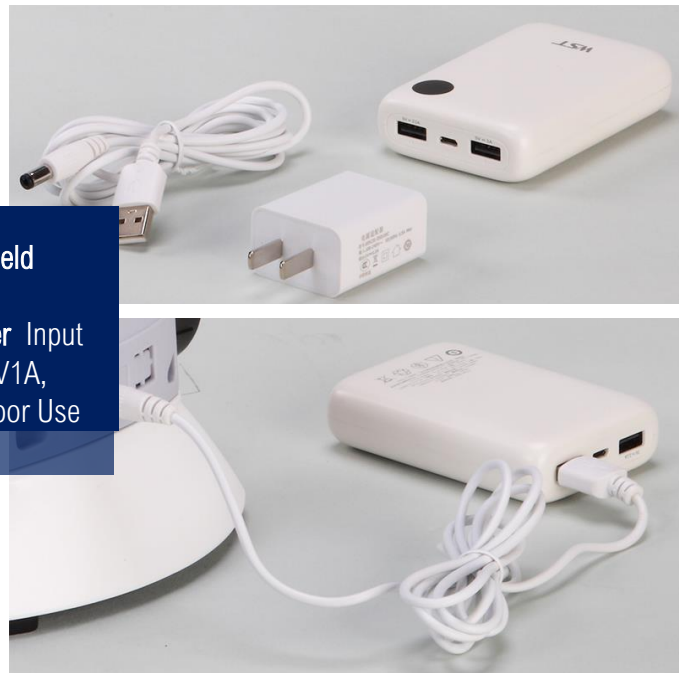

**3W LED Koehler Illumination, Field Diaphragm**  
**Powered By Safety Low Voltage Charger** Input  
Wide Voltage 100V-240V, Output 5V1A,  
Support Power Bank Supply For Outdoor Use

**10x Objective**  
**Observation Effect**

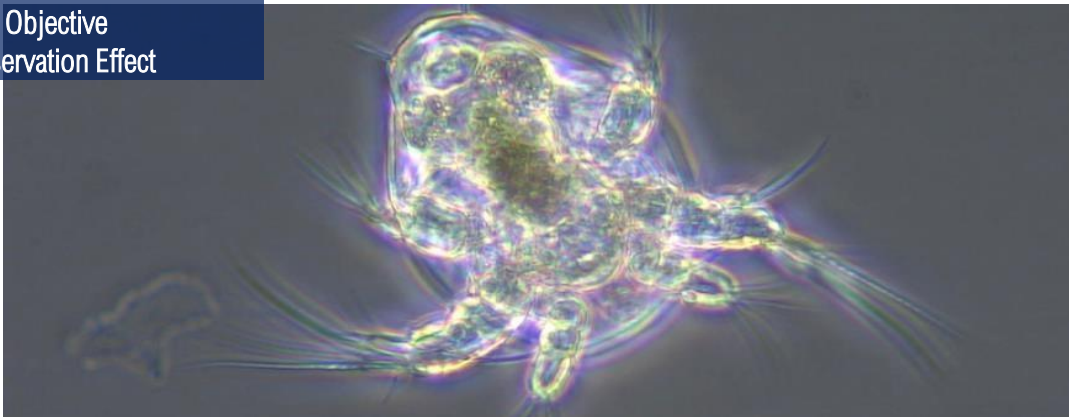

**#Letsgivemore** ❤️  
Thanks to your purchase, a donation will be made to a non-profit foundation that fights against breast cancer and helps most vulnerable communities.



All rights reserved © KALSTEIN France S. A. S.,  
2 Rue Jean Lantier • 75001 Paris •  
+33 1 78 95 87 89 / +33 6 80 76 07 10 •  
<https://kalstein.eu>  
KALSTEIN FRANCE, S. A. S





Items	YR0230A Inverted Biological Microscope	YR0230A	YR0230A
<b>Head</b>	Seidentopf Trinocular Head Inclined 45°, Interpupillary Distance 48~76mm, Light Split Switch E100:P0 / E20:P80	●	●
<b>Eyepiece</b>	WF10x/22mm, Dia.30mm, High Eyepoint,, Diopter Adjustable	●●	●●
	WF15X/16mm, Dia.30mm, High Eyepoint, Diopter Adjustable	○○	○○
	WF20X/12mm, Dia.30mm, High Eyepoint, Diopter Adjustable	○○	○○
<b>Nosepiece</b>	Quintuple	●	●
<b>LWD Infinity Plan FL Semi-APO Objectives</b>	L Plan FL 4x/0.11 W.D.=12.1mm	○	○
	L Plan FL 10x/0.25 W.D.=10.3mm	○	○
	L Plan FL 20x/0.45 W.D.=5.8mm	○	○
	L Plan FL 40x/0.65 W.D.=5.1mm	○	○
<b>LWD Infinity Plan PH+BF FL Semi-APO Objectives</b>	L Plan FL PHP 4x/0.10 W.D.=9.2mm	○	○
	L Plan FL PHP 10x/0.25 W.D.=10.3mm	●	●
	L Plan FL PHP 20x/0.45 W.D.=5.8mm	●	●
	L Plan FL PHP 40x/0.65 W.D.=5.1mm	●	●
<b>Phase Contrast</b>	Centering Telescope 11x	○	○
	Annular Spot 4x	○	○
	Annular Spot 20x/ 40x	●	●
	Annular Spot 10x	●	●
<b>Working Stage</b>	Mechanical Stage Size 210x241mm, Round Slide Size Φ110mm	●	●
	Attachable Mechanical Stage For 96 Holes Plate Moving Range 128x80mm	○	○
	Culture Dish Holder 65mm	○	○
	Culture Dish Holder 54mm	●	●
	Culture Dish Holder 35mm	○	○
	Holder For Blood Cell Counter	○	○
	Universal Holder (New Accessory 2021) Round Glass Holder (New Accessory 2021)	○	○
<b>Condenser</b>	Long Working Distance, Quickly Detachable, N.A.0.3, Working Distance 72mm (With Condenser), 195mm (Without Condenser).	●	●
<b>Tranmist Illumination</b>	Koehler Illumination Halogen 6V/30W, Input Voltage 100V~240V	●	○
	Koehler Illumination 5W LED, Powered By Safety Low Voltage Charger, Input Wide Voltage 100V-240V, Output 5V1A, Support Power Bank Supply For Outdoor Use	○	●
<b>Reflect Illumination</b>	Koehler Illumination 5W LED, Powered By Safety Low Voltage Charger, Input Wide Voltage 100V-240V, Output 5V1A, Support Power Bank Supply For Outdoor Use	-	●
	Polarizing Set		●
<b>Power</b>	ECO, Auto Power Off System. Power Off Automatically Upon User Leaving 10 Minutes, Power On Automatically Upon User Approaching Detected, This Function Can Be Shut Down Manually	○	○



#Letsgivemore

Thanks to your purchase, a donation will be made to a non-profit foundation that fights against breast cancer and helps most vulnerable communities.



All rights reserved © KALSTEIN France S. A. S.,  
2 Rue Jean Lantier • 75001 Paris •  
+33 1 78 95 87 89 / +33 6 80 76 07 10 •  
<https://kalstein.eu>  
KALSTEIN FRANCE, S. A. S



<b>Filter</b>	Blue, Dia.34mm	●	●
	Green, Dia.34mm	●	●
	Amber, Dia.34mm	○	○
	Grey, Dia.34mm	○	○
<b>Adapter</b>	C-Mount 0.5x, Focus Adjustable	○	○
	C-Mount 0.75x, Focus Adjustable	○	○
	C-Mount 1.0x, Focus Adjustable	○	○
<b>Epi Fluorescence Illumination</b>	Upgrade to YR0230A Inverted Fluorescence Microscope With: B,G China Fluorescent Filter 3 Holes Fluorescent Slide Unit, With Field Diaphragm, Center Adjustable 100W Mercury Lamp House 100W Mercury Power Box, Digital Disp. Ultraviolet Protection Barrier	○	○
	Upgrade to YR0230A Inverted Fluorescence Microscope With: B,G,U,UV China Fluorescent Filter 3 Holes Fluorescent Slide Unit, With Field Diaphragm, Center Adjustable 100W Mercury Lamp House 100W Mercury Power Box, Digital Disp. Ultraviolet Protection Barrier	○	○
	Upgrade to YR0230A L2 Inverted Fluorescence Microscope With: B,G China Fluorescent Filter 3 Holes Fluorescent Slide Unit, With Field Diaphragm, Center Adjustable 5W LED Lamp House 5W LED Power Box Ultraviolet Protection Barrier	○	○
	Upgrade to YR0230A-L4 Inverted Fluorescence Microscope With: B,G,U,UV China Fluorescent Filter 3 Holes Fluorescent Slide Unit, With Field Diaphragm, Center Adjustable 5W LED Lamp House 5W LED Power Box Ultraviolet Protection Barrier	○	○
<b>Package</b>	Packing Size: 660mmx590mmx325mm		
<b>Weight</b>	Gross Weight: 18 kgs, Net Weight: 13.5kgs		
Note: "●" In Table Is Standard outfits, "○" Is Optional Accessories.			

## Product Accessories



YR0230A-1022  
WF10x/22mm



YR0230A-1516  
WF15x/16mm



YR0230A-2012  
WF20x/12mm



YR0230A  
ECO, Auto Power Off  
System



#Letsgivemore

Thanks to your purchase, a donation will be made to a non-profit foundation that fights against breast cancer and helps most vulnerable communities.



All rights reserved © KALSTEIN France S. A. S.,  
2 Rue Jean Lantier • 75001 Paris •  
+33 1 78 95 87 89 / +33 6 80 76 07 10 •  
<https://kalstein.eu>  
KALSTEIN FRANCE, S. A. S





YR0230A LWD Infinity Plan Objective: 10x, 20x, 40x  
YR0230A LWD Infinity Plan Phase Contrast Objective: 20x



YR0230A-10  
C-Mount 1.0x,  
Focus Adjustable



YR0230A Centering Telescope 11x (Optional) &  
A5C.2611 Annular Spot 10x/20x/40x



YR0230A-75  
C-Mount 0.75x, Focus  
Adjustable



YR0230A-D4  
Mechanical Stage Size  
210x241mm Round  
Slide Size  $\Phi$ 110mm



YR0230A-05  
C-Mount 0.5x,  
Focus Adjustable



YR0230A & YR0230A-35  
Culture Dish Holder 65mm & Culture Dish  
Holder 35mm (Optional)



YR0230A-54  
Culture Dish Holder 54mm



#Letsgivemore

Thanks to your purchase, a donation will be made to a non-profit foundation that fights against breast cancer and helps most vulnerable communities.



All rights reserved © KALSTEIN France S. A. S.,  
2 Rue Jean Lantier • 75001 Paris •  
+33 1 78 95 87 89 / +33 6 80 76 07 10 •  
<https://kalstein.eu>  
KALSTEIN FRANCE, S. A. S





YR0230A-D4  
Long Working Distance  
Quickly Detachable  
N.A.0.3 Condenser



YR0230A  
Filter: Blue, Green;  
Amber; Grey (Optional)

## Product Upgrade

YR0230A-TR  
Inverted Microscope With Transmit &  
Reflect Light Source



#Letsgivemore

Thanks to your purchase, a donation will be made to a non-profit foundation that fights against breast cancer and helps most vulnerable communities.



All rights reserved © KALSTEIN France S. A. S.,  
2 Rue Jean Lantier • 75001 Paris •  
+33 1 78 95 87 89 / +33 6 80 76 07 10 •  
<https://kalstein.eu>  
KALSTEIN FRANCE, S. A. S.





YR0230A& YR0230A-L  
Inverted Fluorescence Microscope



## Product Size(mm)

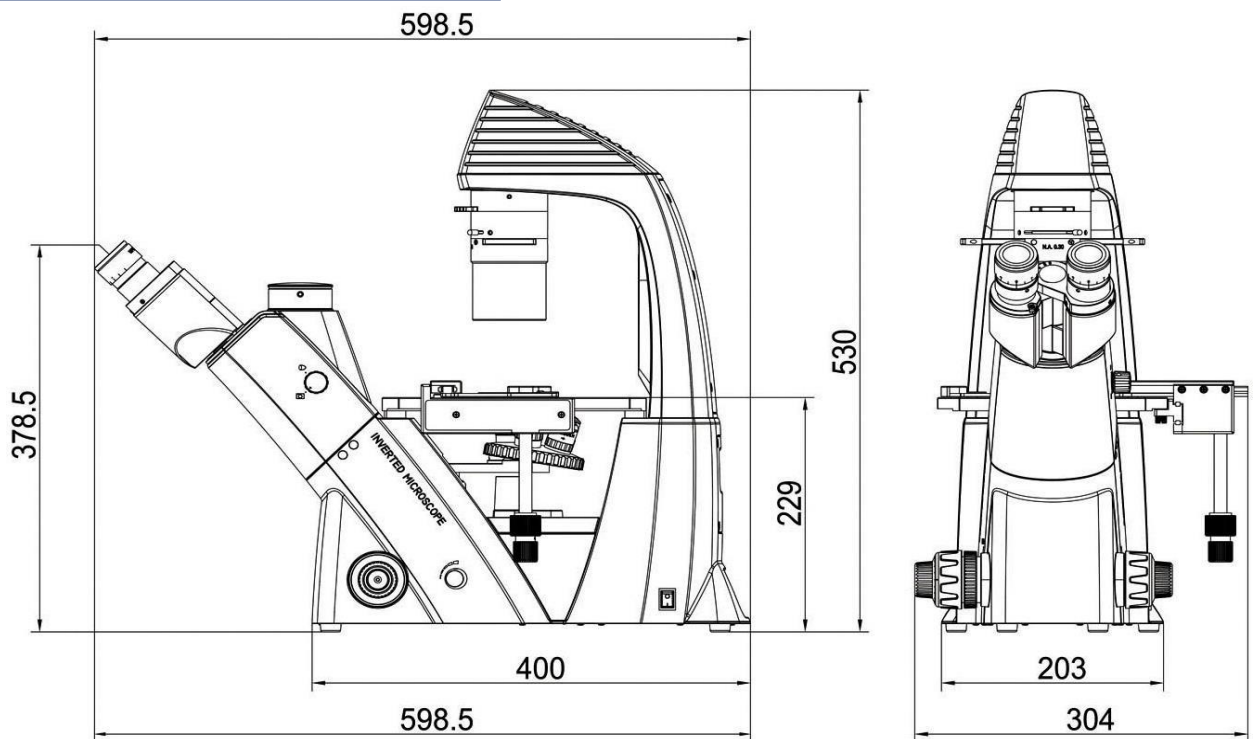

#Letsgivemore

Thanks to your purchase, a donation will be made to a non-profit foundation that fights against breast cancer and helps most vulnerable communities.



All rights reserved © KALSTEIN France S. A. S.,  
2 Rue Jean Lantier • 75001 Paris •  
+33 1 78 95 87 89 / +33 6 80 76 07 10 •  
<https://kalstein.eu>  
KALSTEIN FRANCE, S. A. S.



## General Layout Diagram

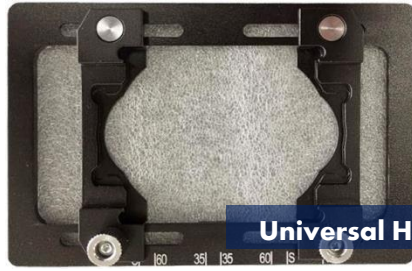

Universal Holder

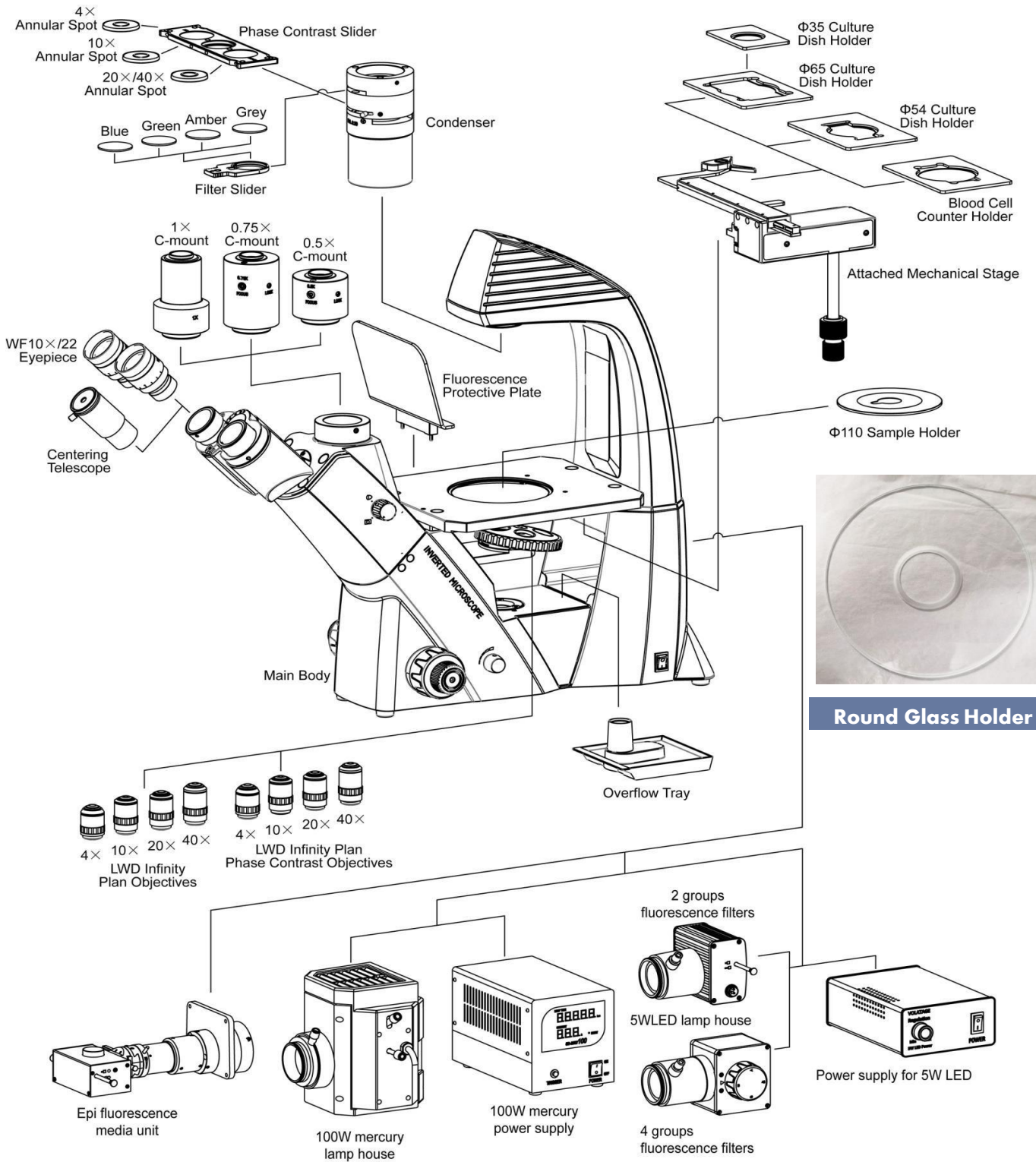

#Letsgivemore

Thanks to your purchase, a donation will be made to a non-profit foundation that fights against breast cancer and helps most vulnerable communities.



All rights reserved © KALSTEIN France S. A. S.,  
 2 Rue Jean Lantier • 75001 Paris •  
 +33 1 78 95 87 89 / +33 6 80 76 07 10 •  
<https://kalstein.eu>  
 KALSTEIN FRANCE, S. A. S.







# Kalstein®

A different accompaniment, at your service

#LETSGIVEMORE

## WITH THE ACQUISITION OF A KALSTEIN EQUIPMENT

YOU MAKE A CONTRIBUTION TO:



### Fundación Jacinto Convit

<https://www.jacintoconvit.org/>



<https://onetreepanted.org>



### Humatem

Solidarité et coopération  
biomédicale

<https://www.humatem.org/>



### MANIAPURE FOUNDATION USA

<https://www.maniapurefoundation.org/>



**Articles Kalstein**  
(Social Networks and Official Websites)

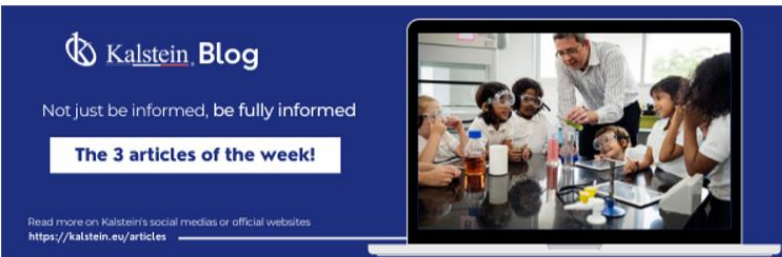

**Kalstein Blog**  
Not just be informed, be fully informed  
**The 3 articles of the week!**  
Read more on Kalstein's social medias or official websites  
<https://kalstein.eu/articles>



PARIS - FRANCE  
**HEADQUARTER**  
2 Rue Jean Lantier  
75001 Paris - France

**Tlf:** +33 (0) 01 78 95 87 89  
**Cel:** +33 (0) 6 80 76 07 10  
[sales@kalstein.eu](mailto:sales@kalstein.eu)

<https://kalstein.eu/>  
<https://www.kalstein.fr/>

1



**How does the climate affect your microscope?**

microscope is an instrument used for observing objects that are too small to be seen by the naked eye. This is a general definition, but there are some specific types of microscopes that are used for different purposes.



**Article of the week:**  
How does the climate affect your microscope?

Read more on Kalstein's social medias or official websites  
<https://kalstein.eu/articles>

---

2



**What is the importance of the laboratory refrigerator?**

Refrigerators are one of the most important pieces of equipment in a laboratory. They are used to maintain a controlled environment (refrigerated space) for the storage of samples and reagents.



**Article of the week:**  
What is the importance of the laboratory refrigerator?

Read more on Kalstein's social medias or official websites  
<https://kalstein.eu/articles>

**Kalstein Training Videos**  
(Youtube Channel and Official Websites)



**Kalstein France - Jacinto Convit Foundation / Allianc...**

23 views • 3 years ago

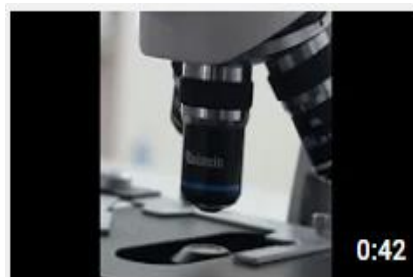

**Kalstein's Microscopes**

445 views • 1 week ago

